



Regardless of the material that constitutes its frame, the functionality and performance of any type of window or door must meet mandatory legal standards that already require outstanding quality.

It is possible to change the performance of any building system—be it Wood, Alu-clad Wood, PVC or Aluminium—in terms of energy, acoustics, weatherstripping, safety, functionality, etc. This can be achieved by using different fillers or support and handling equipment, which are common to most building systems.

The frame, which represents approximately 1/3 of the raw materials, plays an important role in the building system: not only does it characterise the final product (the window or door), but it also has a very strong ENVIRONMENTAL, SOCIAL, ECONOMIC, AESTHETIC and CULTURAL influence.

**The purchase of a product such as a window or a door, with all the consequences that it entails, therefore requires an in-depth consideration which, in today's world, must necessarily go beyond a mere economic and performance assessment. In doing so, over time, it will become a much more responsible and conscious action.**

## WOOD, ETERNAL BEAUTY AND REFINEMENT



CUSTOMISABLE



ECO-FRIENDLY AND SUSTAINABLE



LIVING MATTER CARVED BY MAN



WOODWORKING IS ART



## Specifications



### DESCRIPTION

Wooden windows built with 3-lamella glulam. Available types of wood for you to choose: pine, fir, oak, okoume, larch and others on request. Double gasket seal made of high-performance and high-durability polyurethane foam with great memory properties.



### WOOD PROTECTION

The wood undergoes a surface treatment with products made of acrylic resin emulsions. Three to six coats of treatment are applied depending on the finish and required durability.



### DIMENSIONS

Fixed glulam frame nominal section: 68 x 79 mm.  
Moveable glulam sash nominal section: 68 x 78 mm.



### HARDWARE

Standard hardware: Maico Multi-Matic. It includes a tilt and turn mechanism, a flush bolt and a micro-ventilation system. The window is complete with burglarproof strike plates and locking points along the entire perimeter.



### GASKETS AND WEATHERSTRIPPING

3-rebate window profile with a double gasket seal. Shaped glazing bead available in different models. It is silicone sealed both on the interior and exterior sides (standard procedure). Water drainage is carried out through a standard drip edge, attached to the sash, or a retrofit drip edge (available on request).



### WINDOW GLAZING

Low-E double-glazed window with a single air gap insulated with standard Argon gas, in accordance with the current legislation. The window panes vary in thickness and type (i.e. with solar control films, safety glass, soundproof glass, satin glass, and so on) depending on the customer's needs. Standard black warm-edge spacer (more types and colours available on request).



### THERMAL TRANSMITTANCE\*

The window can reach a heat insulation value (UW) of up to 1.23 W/m<sup>2</sup>K

\*in accordance with the UNI EN ISO 10077-1 and 2 standard, the heat insulation value was calculated on a 1-sash window made of fir wood of 1230 x 1480 mm size (in accordance with the UNI EN 14351-1 standard) and low-E glazing with Ug value = 1.1 (W/m<sup>2</sup>K)



### SOUND INSULATION

From 31 to 45 dB depending on the glass noise reduction value.



Window - Interior Angle



Window - Exterior Angle



Window - Interior View



Window - Exterior View



French Window - Exterior Angle



French Window - Interior View

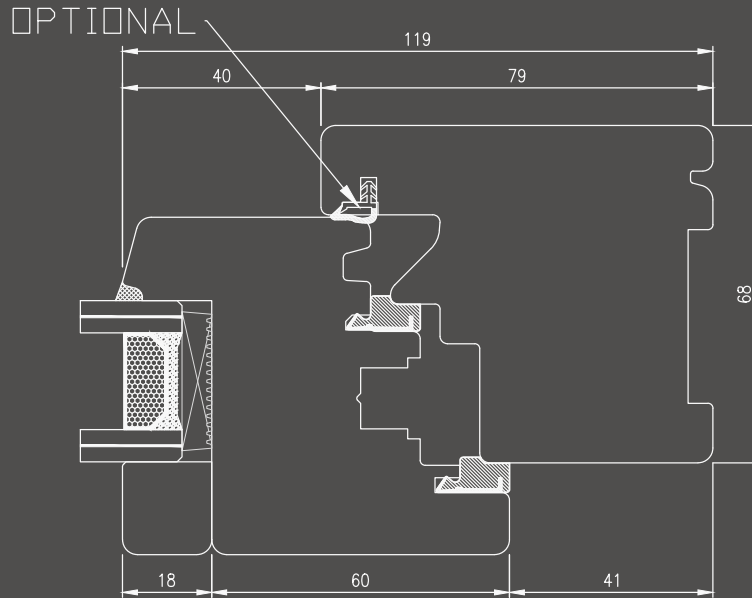

**Upper rail/lateral mullion  
(windows and French windows)**

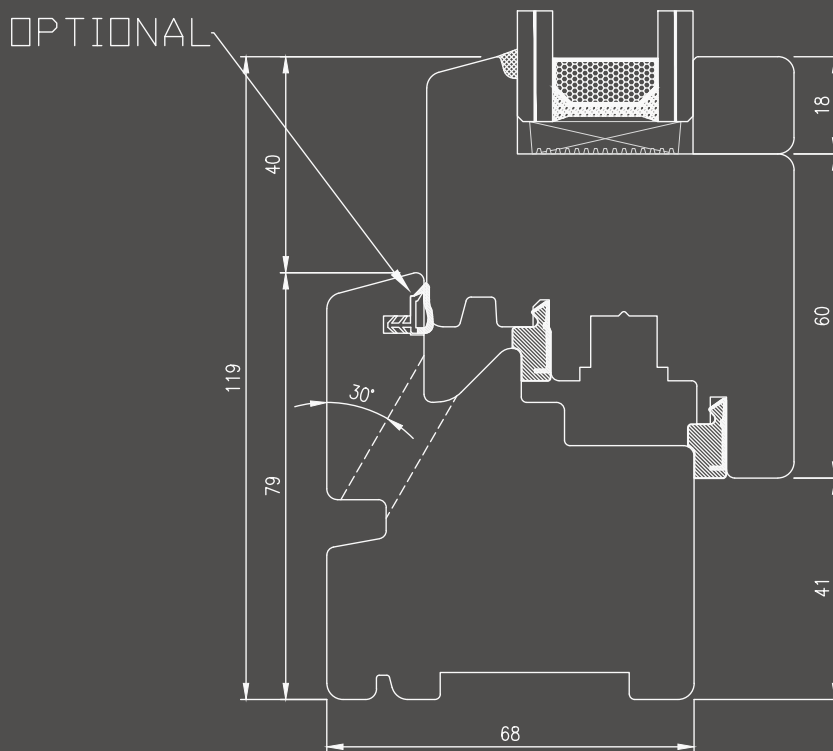

**Bottom rail with standard drip edge  
(windows)**

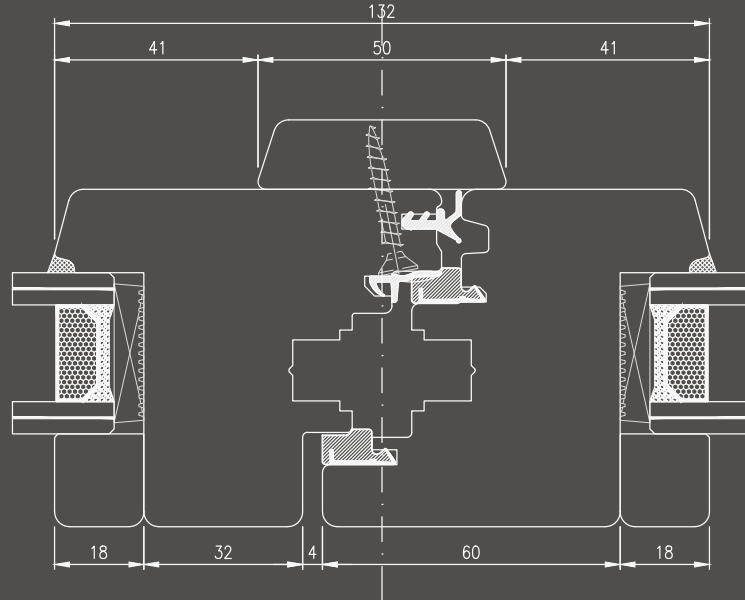

**A5 standard central mullion  
(windows and French windows)**

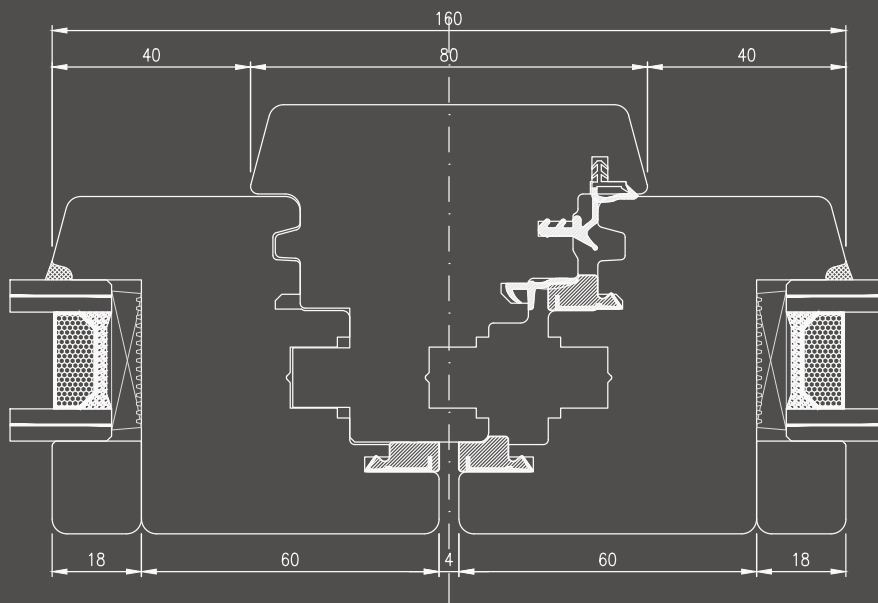

**A9 central mullion  
(windows and French windows)**

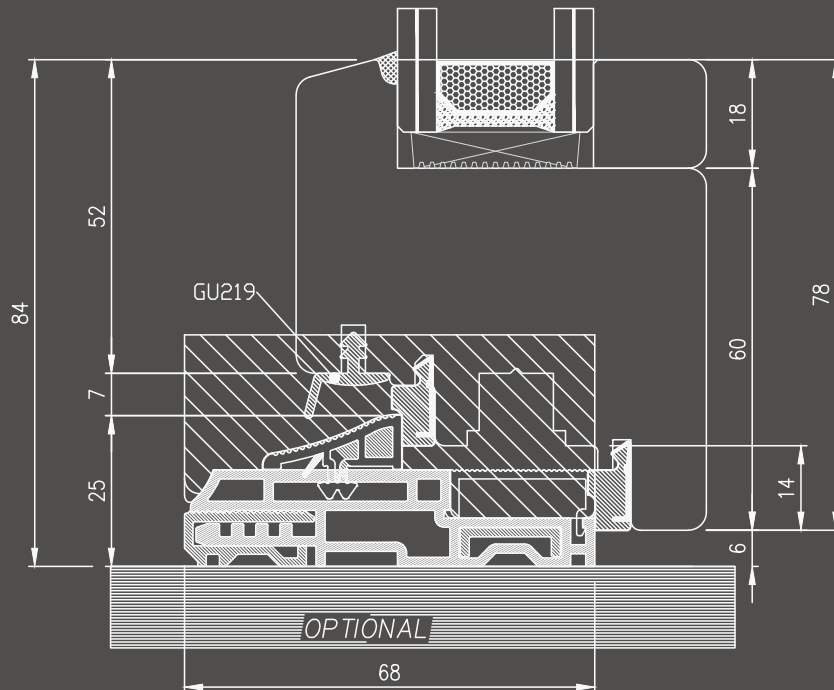
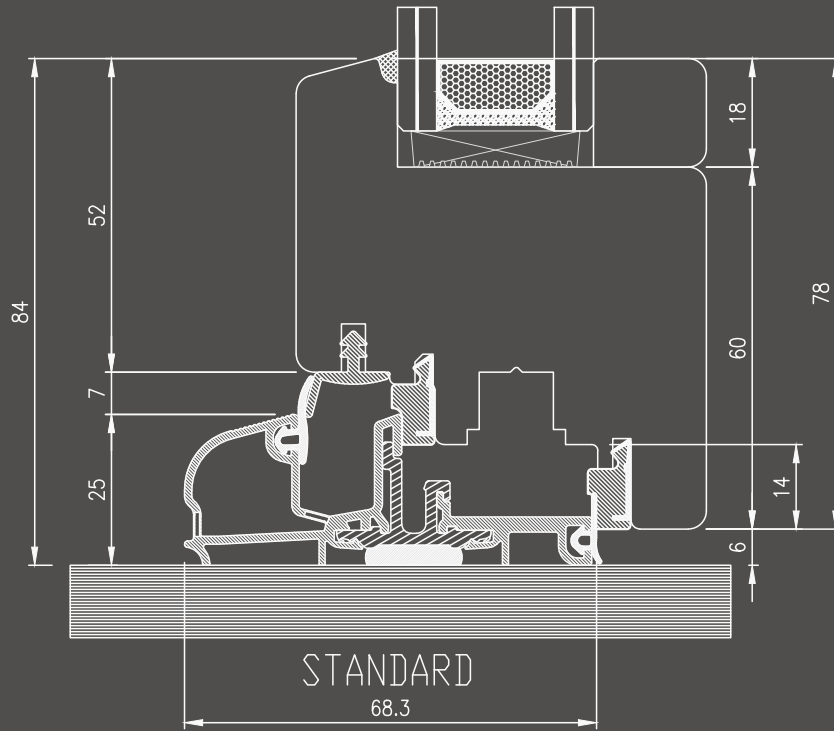

**Bottom rail  
(French windows with threshold)**



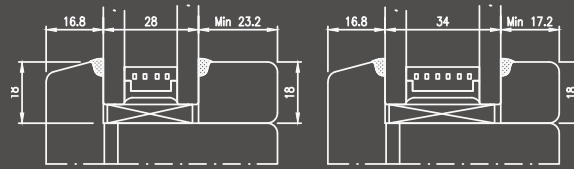

Type 3 Glazing Bead (Squared)



Type 2 Glazing Bead (Beveled)

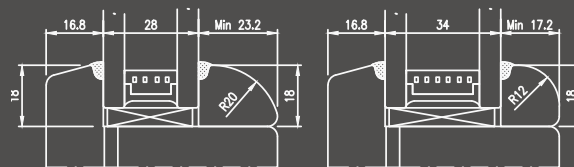

Type 1 Glazing Bead (Rounded)

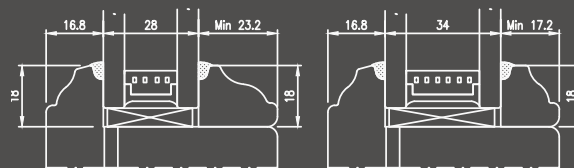

Type 4 Glazing Bead (Baroque)

**Types and styles of silicone-sealed glazing beads**

## Strengths



### FINISHES OF YOUR CHOICE

The 32 standard finishes you can choose from are as soft as skin, as transparent as the water they're made of, as colourful as the nature they're friends with, and in tune with the trends. Moreover, you also have the option of a custom finish of your choice.



### STANDARD WARRANTY\*



Window functionality - 10 YEARS



No fogging inside the double- or triple-glazed unit - 10 YEARS



No delamination of the glulam profile of wooden and alu-clad wooden windows - 10 YEARS

\*See conditions in the warranty certificate and article 5 of the general conditions of sale.

\*\*According to the values defined by the ISO 4628-2-4-5, UNI EN 13722 and UNI 8941-1-2-3 standards



### PREMIUM WARRANTY\*



Window functionality - 10 YEARS



Coating durability of windows painted with long-life ral 9001, 9010, 9016, 1013 - 15 YEARS\*\*



Coating durability of windows painted with dark long-life wood stains - 10 YEARS\*\*



No fogging inside the double- or triple-glazed unit - 10 YEARS



No delamination of the glulam profile of wooden and alu-clad wooden windows - 10 YEARS



### DESIGN

Our windows are designed to look and feel very modern thanks to the clear lines that make up their shape. Furthermore, these up-to-date, carefully designed building systems adapt to any environment to meet our customers' needs for individuality and functionality.



"Type 1" rounded glazing bead



"Type 3" squared glazing bead

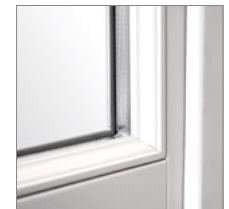

"Type 4" baroque glazing bead



A5 asymmetrical central mullion

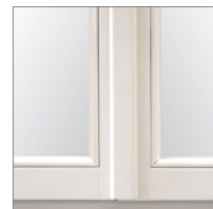

"0" A6 central mullion



A9 symmetrical central mullion



Concealed hinge



Z-shaped frame (available option)



Flush casement with concealed hinge



T1 window trim



T2 flush window trim

## Finishes

### GROUP 1 - STANDARD FINISHES

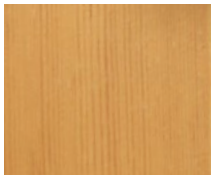

Wood: Pine  
Colour: Natura

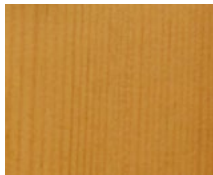

Wood: Pine  
Colour: Ambra

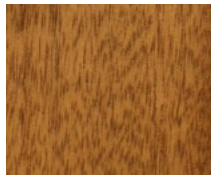

Wood: Okoume  
Colour: Ambra

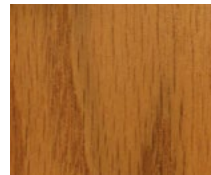

Wood: Oak  
Colour: Ambra



Wood: Pine  
Colour: Cannella

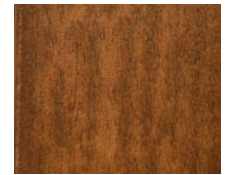

Wood: Okoume  
Colour: Cannella

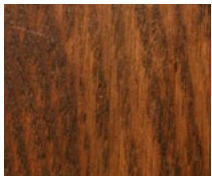

Wood: Oak  
Colour: Cannella

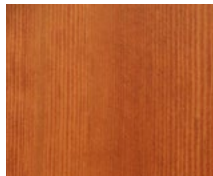

Wood: Pine  
Colour: Miele

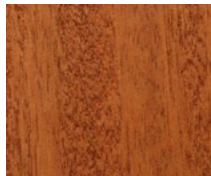

Wood: Okoume  
Colour: Miele

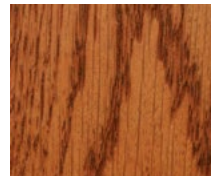

Wood: Oak  
Colour: Miele

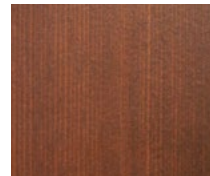

Wood: Pine  
Colour: Brandy

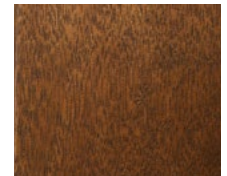

Wood: Okoume  
Colour: Brandy

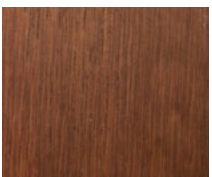

Wood: Oak  
Colour: Brandy

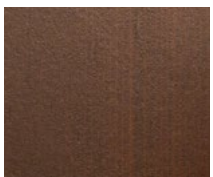

Wood: Pine  
Colour: Moro

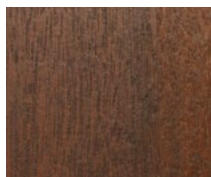

Wood: Okoume  
Colour: Moro

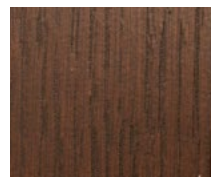

Wood: Oak  
Colour: Moro

### GROUP 2 - FINISHES WITH SURCHARGE

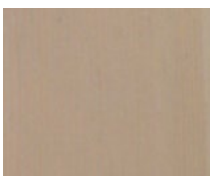

Wood: Pine  
Colour: Corda

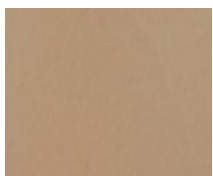

Wood: Okoume  
Colour: Corda



Wood: Oak  
Colour: Corda



Wood: Pine  
Colour: Fieno

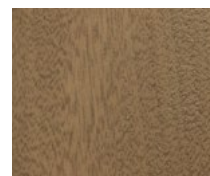

Wood: Okoume  
Colour: Fieno

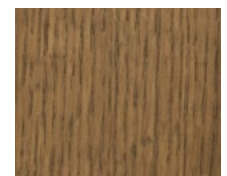

Wood: Oak  
Colour: Fieno

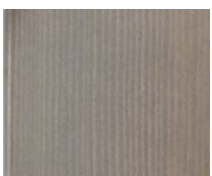

Wood: Pine  
Colour: Argilla

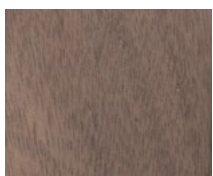

Wood: Okoume  
Colour: Argilla

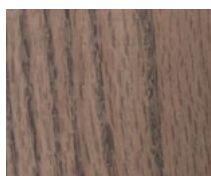

Wood: Oak  
Colour: Argilla

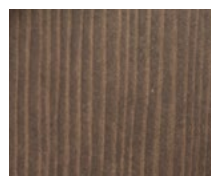

Wood: Pine  
Colour: Vinaccia

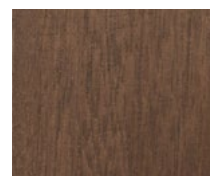

Wood: Okoume  
Colour: Vinaccia

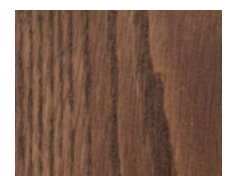

Wood: Oak  
Colour: Vinaccia



Wood: Pine  
Colour: Sbiancato Cenere



Wood: Pine  
Colour: Rat 9010

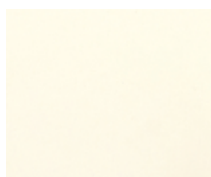

Wood: Okoume  
Colour: Rat 9001



Wood: Oak  
Colour: Rat 1013

Colours are for illustrative purposes only.  
They may vary.

MORE RAL COLOURS ON REQUEST

## WINDOW OPENING TYPES

### FIXED WINDOW

WITH GLAZING BEAD



SCREW-MOUNTED SASH



### FIXED FRENCH WINDOW

WITH GLAZING BEAD



### WINDOWS

TILT



1 SASH



2 SASHES



3 SASHES



### FRENCH WINDOWS

1 SASH



2 SASHES



3 SASHES



### LOCKABLE FRENCH WINDOWS

1 TILT&TURN SASH



1 SASH



2 SASHES



### SEGMENTAL ARCH

FIXED



1 SASH



2 SASHES



3 SASHES



### ROUND ARCH

FIXED



1 SASH



2 SASHES



3 SASHES



### TWO-CENTERED ARCH

FIXED



1 SASH



2 SASHES



3 SASHES



### PORTHOLE

FIXED



1/2 OPENING (ABOVE)  
1/2 FIXED (UNDER)



HORIZONTAL PIVOTING



### OVAL

FIXED



1 SASH



PIVOTING WINDOW

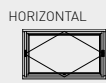

SLIDING WINDOW



SLIDING FRENCH WINDOW



LIFT-AND-SLIDE FRENCH WINDOW



1 SASH OUTSIDE THE WALL



2 SASHES OUTSIDE THE WALL

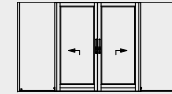

1 SASH INSIDE THE WALL



2 SASHES INSIDE THE WALL

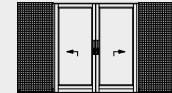

FIXED / OPENING / FIXED

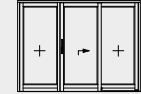

OPENING / FIXED / OPENING

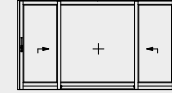

FIXED / OPENING / OPENING / FIXED



OPENING / OPENING / OPENING / OPENING

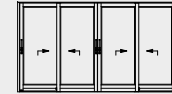

OPENING / OPENING / FIXED



TRAPEZOID



PENTAGON



BEVELED ANGLE



TRIANGULAR









**GIEMME**  
Italian Windows Design



For technical, design and printing purposes, the colours, descriptions, technical and dimensional specifications, as well as any other indication and/or information contained in this catalogue, may be subject to change without prior notice. This may also be due to technological developments or the availability of certain materials and/or components. To avoid any misunderstanding with customers, Giemme Forli srl invites you to verify all product characteristics at authorised sales points. VERS. OV68EVO / PRINT 01-25-EN