

Telaio inferiore e laterale

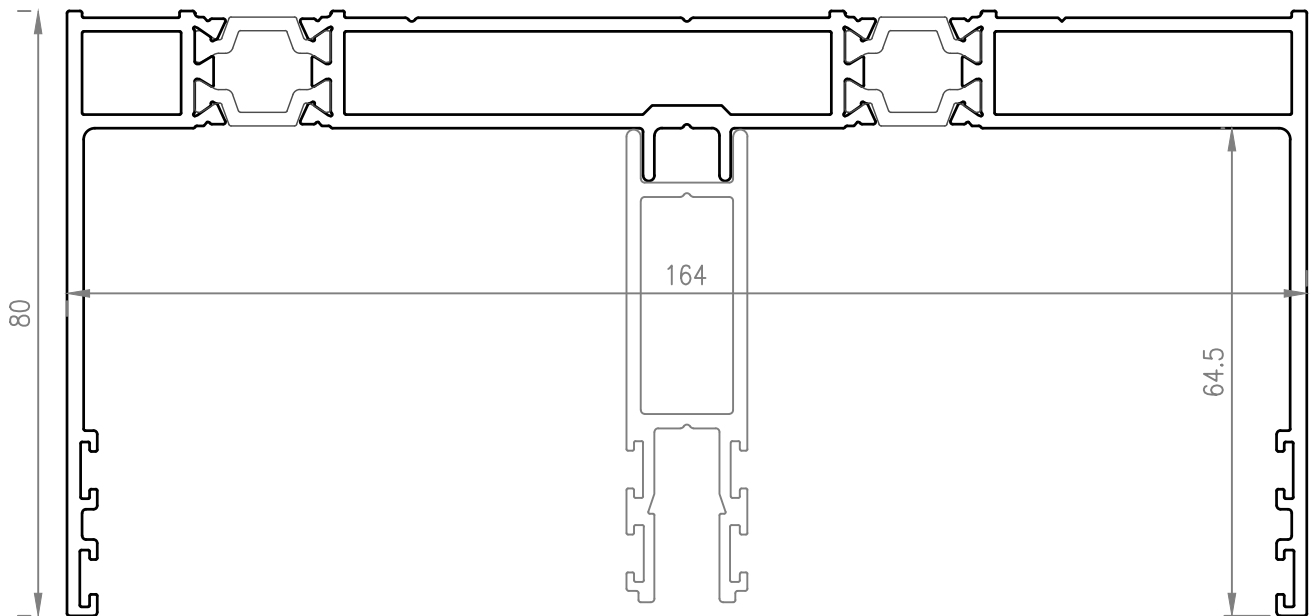

Telaio superiore

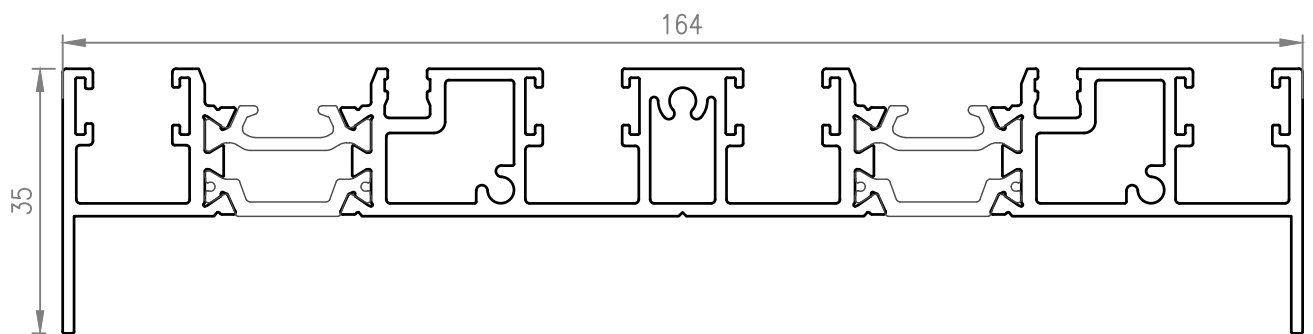

Telaio inferiore per soluzione senza vasca raccogli acqua

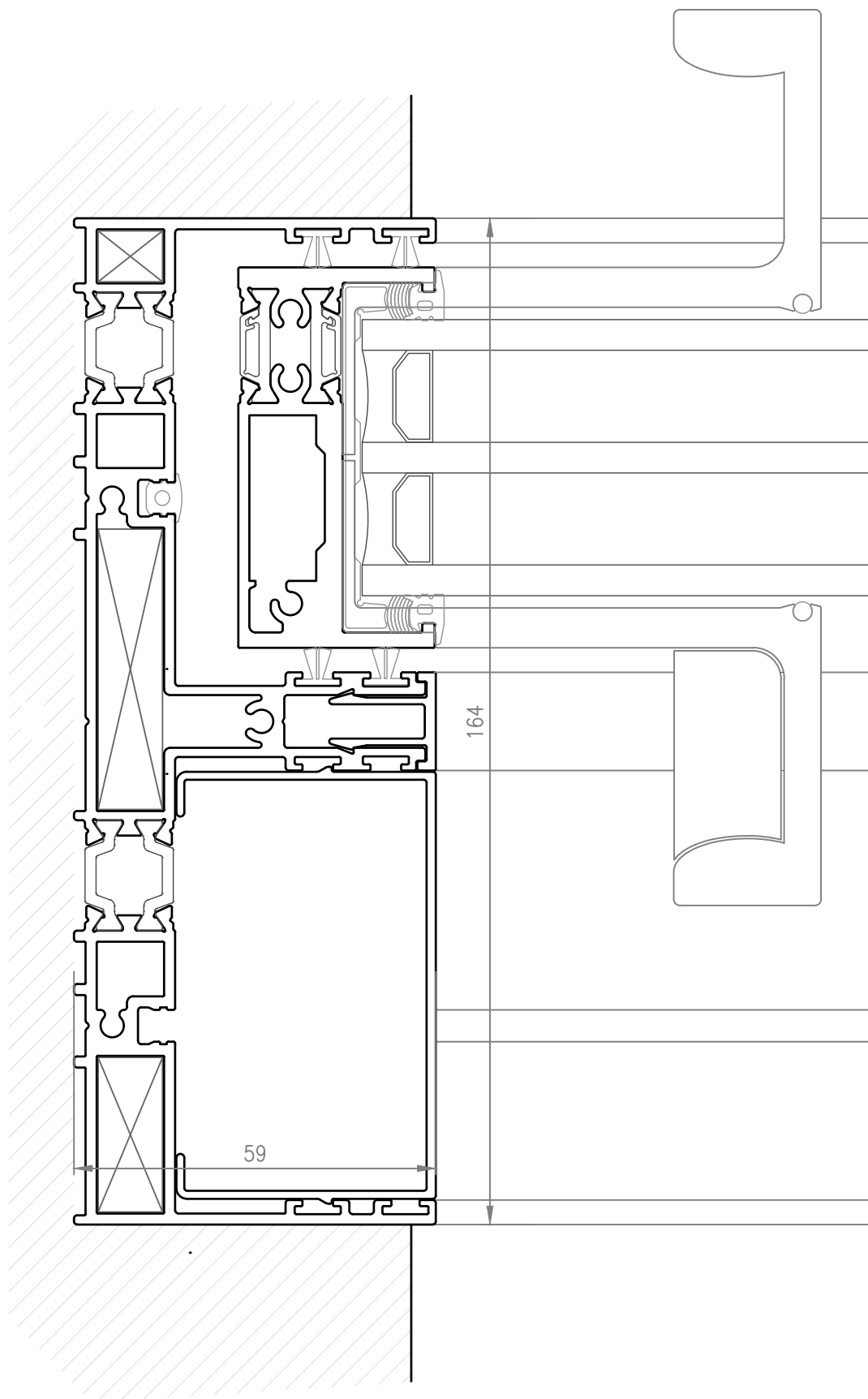

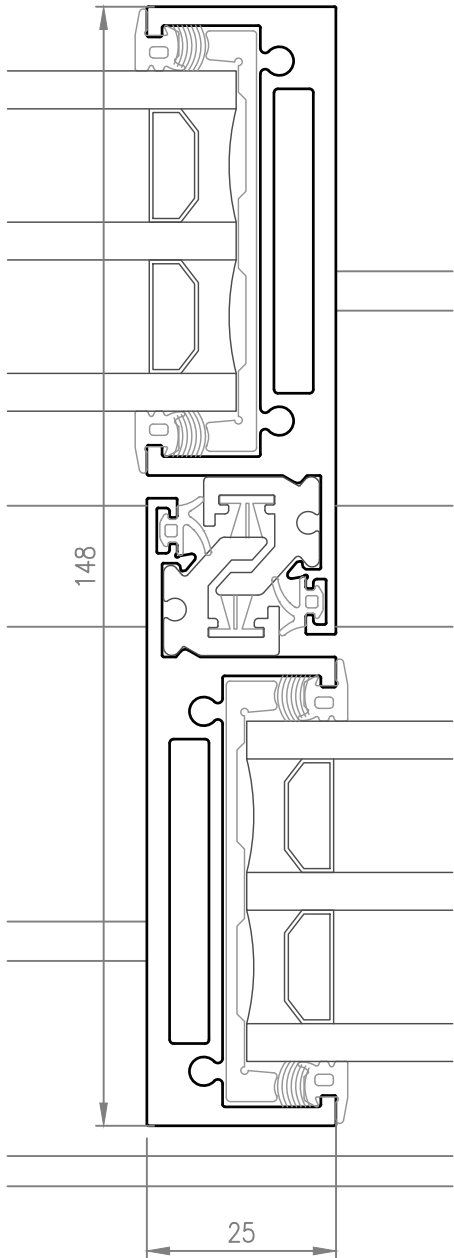

Nodo centrale standard

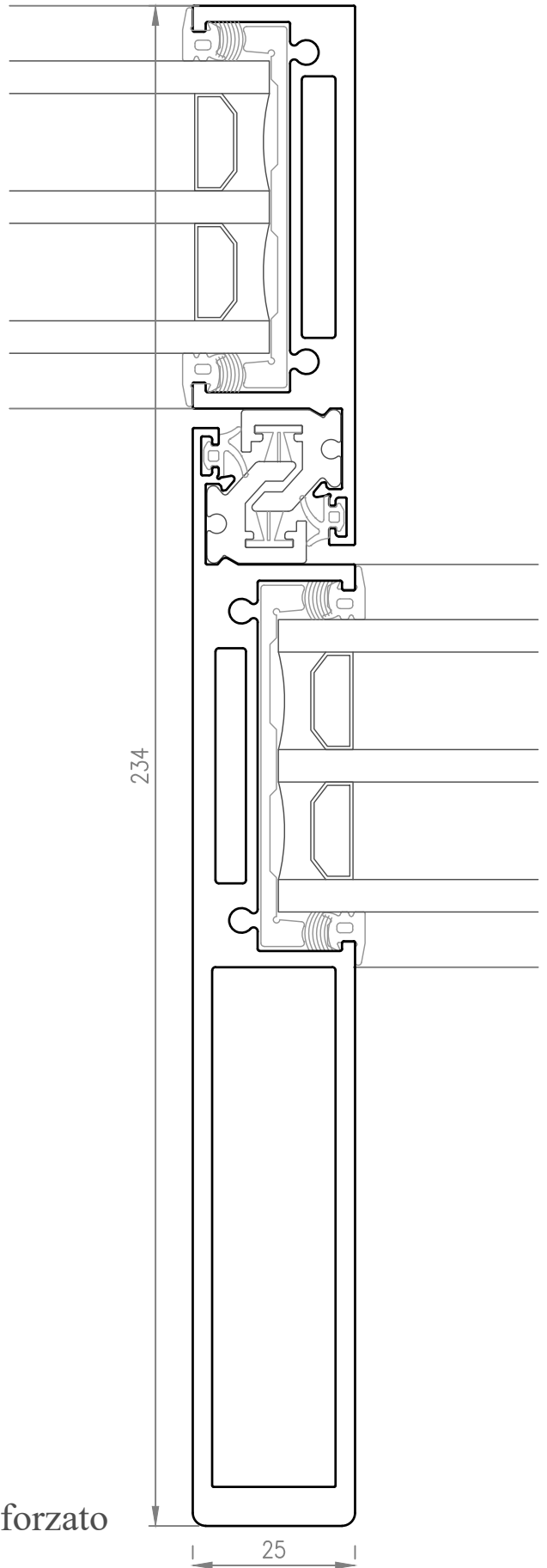

Nodo centrale rinforzato

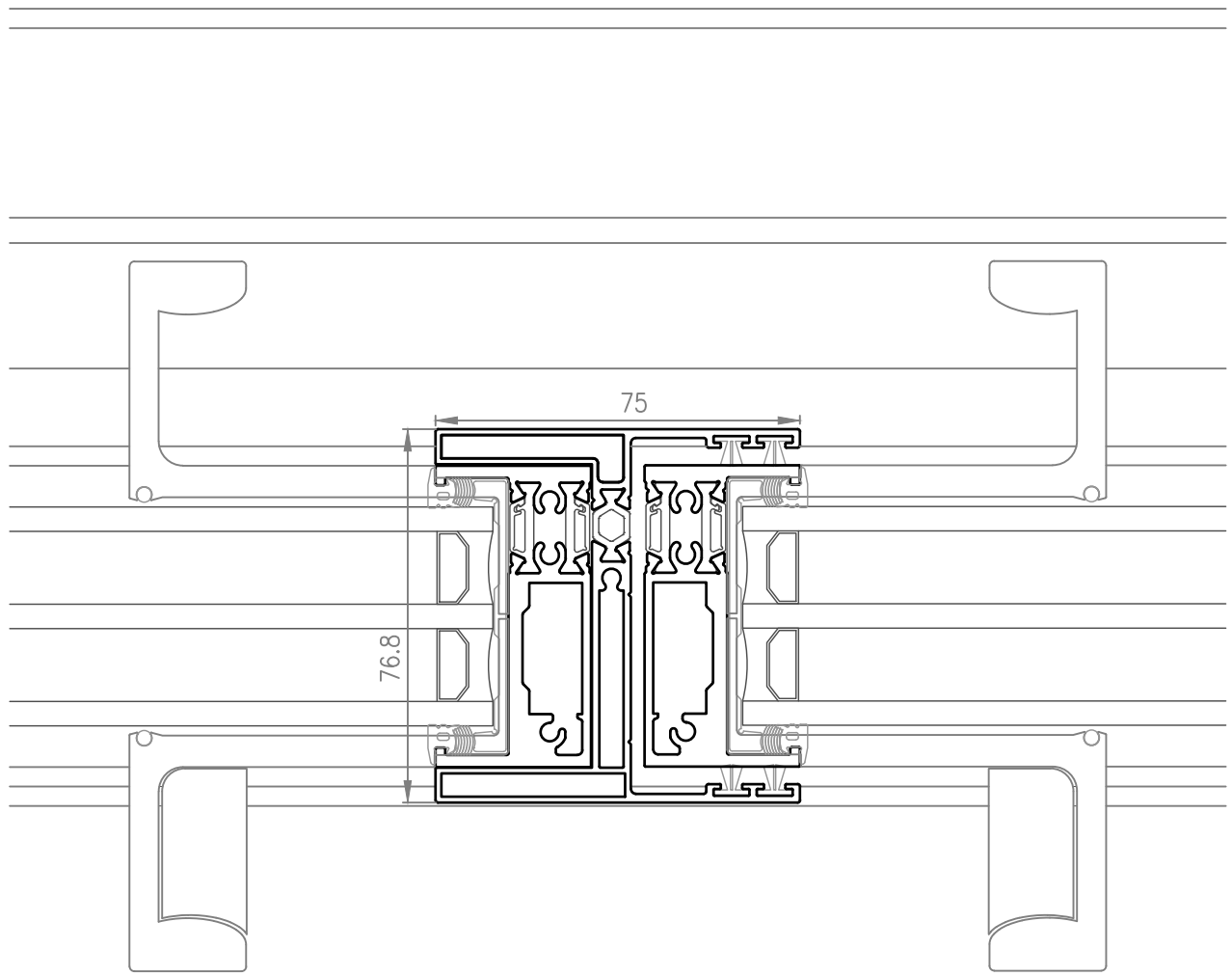

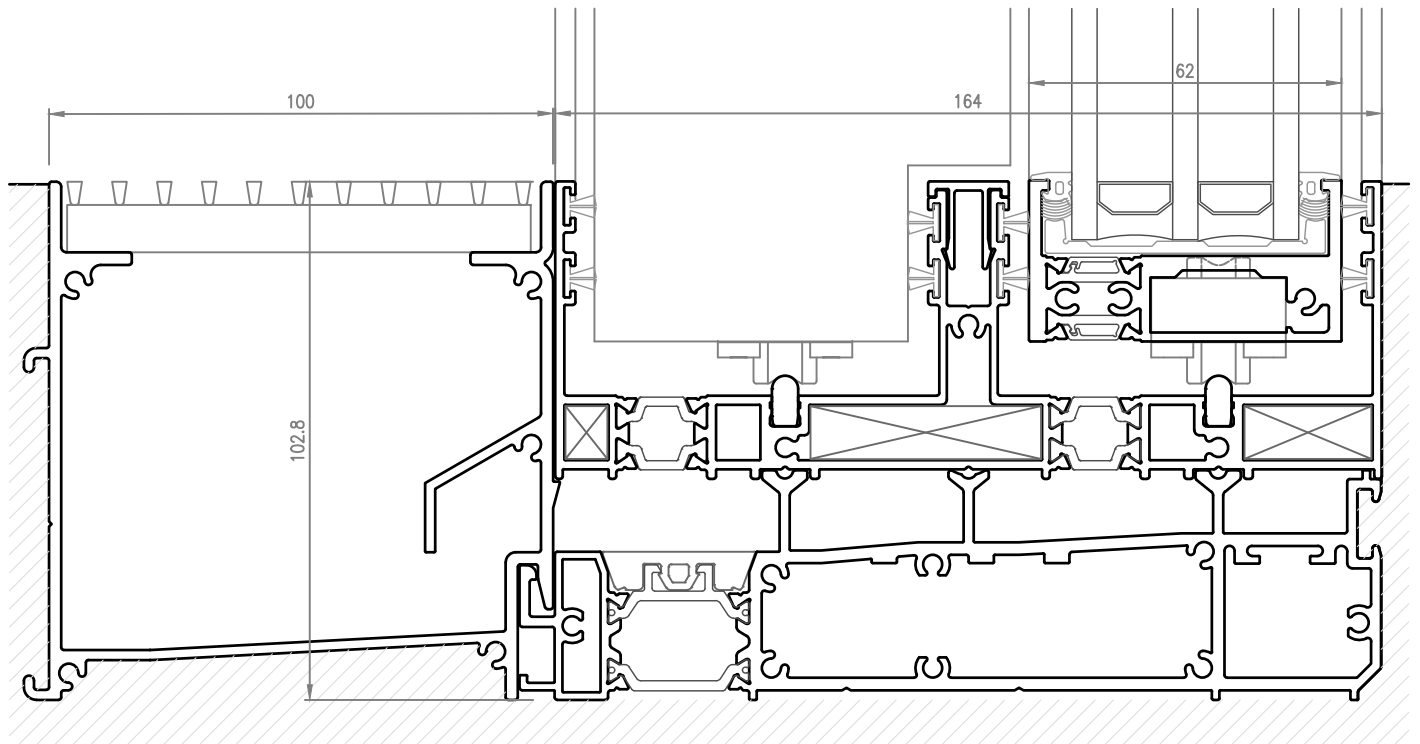

Con vasca raccogli acqua

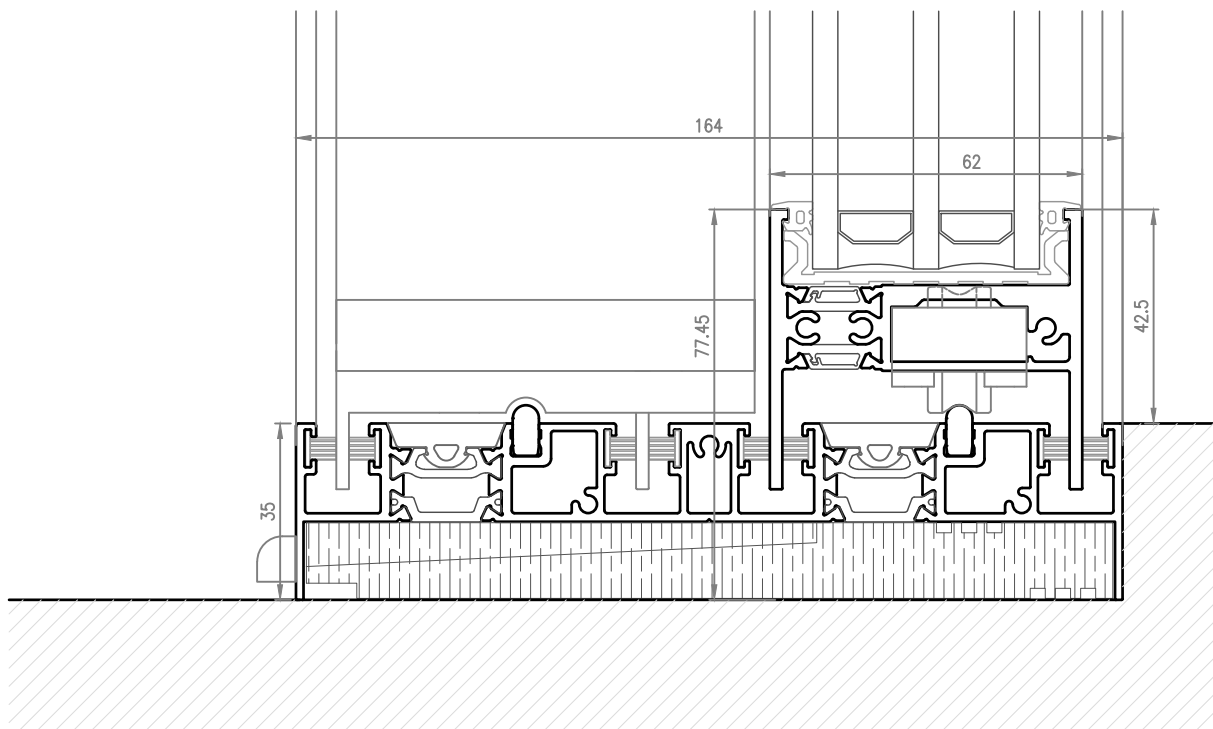

Senza vasca raccogli acqua

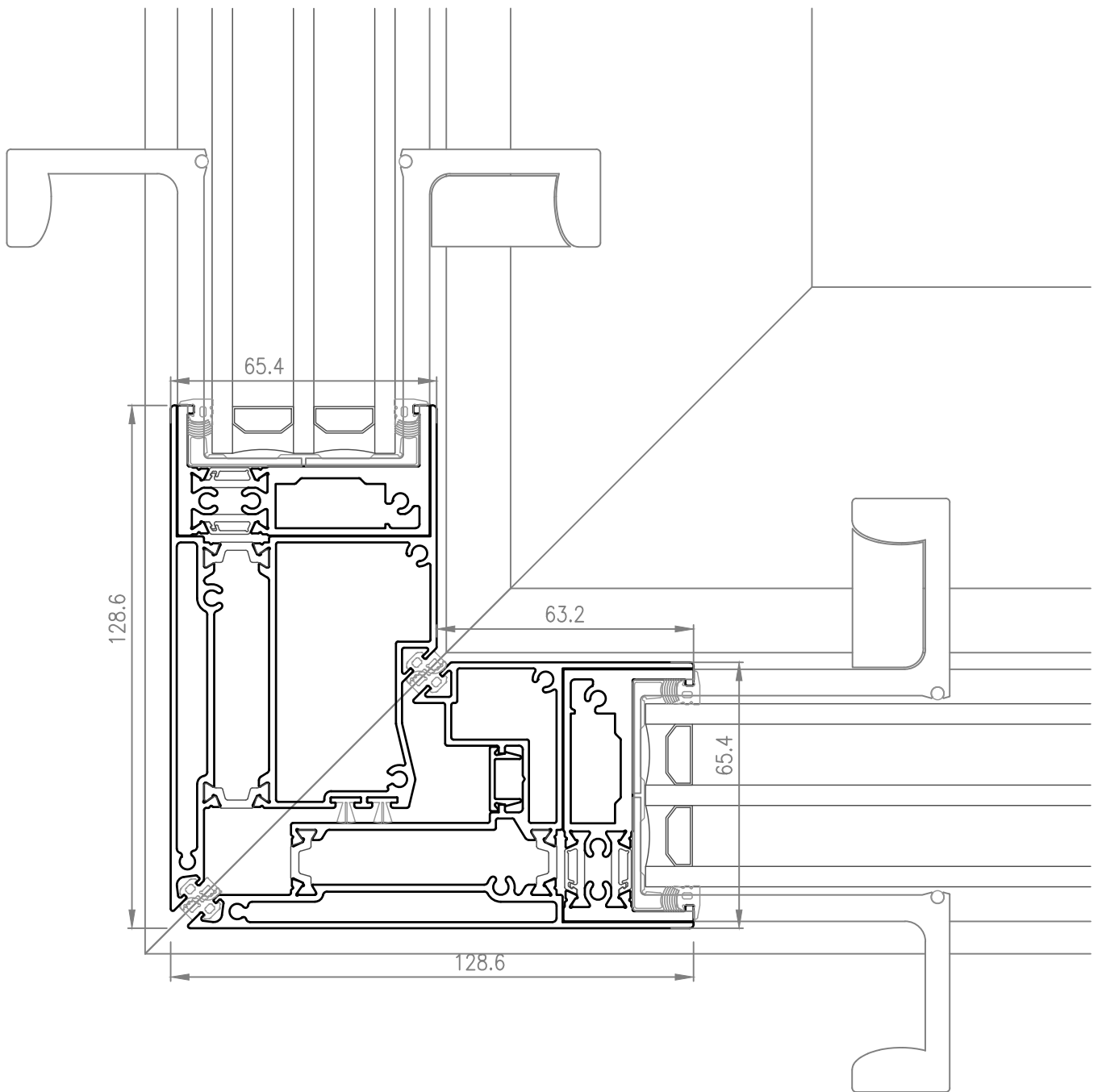

# VETRAZIONE RICHIESTA DA CATALOGO = sp. 45 mm (ad infilare)

